

1-1-1990

Use of metal-filling in spent fuel canisters as an alternative waste form

Rick David Beam
Iowa State University

Follow this and additional works at: <https://lib.dr.iastate.edu/rtd>

 Part of the [Engineering Commons](#)

Recommended Citation

Beam, Rick David, "Use of metal-filling in spent fuel canisters as an alternative waste form" (1990). *Retrospective Theses and Dissertations*. 17987.

<https://lib.dr.iastate.edu/rtd/17987>

This Thesis is brought to you for free and open access by the Iowa State University Capstones, Theses and Dissertations at Iowa State University Digital Repository. It has been accepted for inclusion in Retrospective Theses and Dissertations by an authorized administrator of Iowa State University Digital Repository. For more information, please contact digirep@iastate.edu.

**Use of metal-filling in spent fuel canisters as an
alternative waste form**

by

Rick David Beam

An Abstract of

A Thesis Submitted to the
Graduate Faculty in Partial Fulfillment of the
Requirements for the Degree of
MASTER OF SCIENCE

Signatures have been redacted for privacy

Iowa State University
Ames, Iowa
1990

Use of metal-filling in spent fuel canisters as an
alternative waste form

Rick David Beam

Dr. Bernard I. Spinrad
Department of Nuclear Engineering
Iowa State University

The large amount of spent nuclear fuel being generated in the United States will require the safe storage of this fuel in an underground repository eventually. It is proposed that a new waste form be employed using a current canister design and adding a metal filling around the spent fuel rods. The purpose of this metal filling is to improve the thermodynamic characteristics of the package as well as add a barrier against groundwater penetration. This proposal was tested for its improvement over the current canister design in terms of physical performance as well as an overall cost savings. From this analysis it was found that the use of a metal-filled canister does provide improvement over the current design and is a feasible alternative.

Use of metal-filling in spent fuel canisters as an
alternative waste form

by

Rick David Beam

A Thesis Submitted to the
Graduate Faculty in Partial Fulfillment of the
Requirements for the Degree of
MASTER OF SCIENCE

Department: Mechanical Engineering
Major: Nuclear Engineering

Approved:



In Charge of Major Work

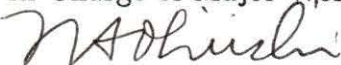

For the Major Department

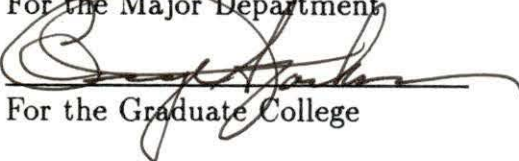

For the Graduate College

Iowa State University
Ames, Iowa
1990

TABLE OF CONTENTS

CHAPTER 1. INTRODUCTION	1
Interim Fuel Storage	1
Criteria for Permanent Storage	2
Proposal for Metal-filled Canisters	3
Possible Drawbacks	5
CHAPTER 2. LITERATURE REVIEW	8
Use of Reprocessing Cycle	8
United States Spent Fuel Storage	9
Monitored Retrievable Storage	11
Repository Storage	12
Metal Filled Canisters	13
CHAPTER 3. SPENT FUEL CANISTERS	15
Reference Canister Design	18
Methods of Filling Canister	18
CHAPTER 4. THERMAL ANALYSIS	21
Generic Canister Analysis	21
Method #1 Analysis	22
Method #2 Analysis	25

Method #3	28
Temperature Drop Analysis for Three Methods	29
CHAPTER 5. CHOICE OF MATERIAL	34
Properties of Metals	34
Binary Alloys	37
Conclusion of Metal Filling Selection	38
CHAPTER 6. COST ANALYSIS	46
Elimination of Bentonite	46
Reduction in Borehole Drilling	47
Decrease in Number of Canisters	48
Other Possible Savings	49
Metal Filling Costs	50
CHAPTER 7. CONCLUSION	52
Thermal Results	52
Protection Against Groundwater Entry	53
Choice of Metal Filling	53
Disadvantages	54
Conclusions and Recommendations for Future Work	54
BIBLIOGRAPHY	56

LIST OF TABLES

Table 4.1:	Effective Canister Conductivity, Method #1	27
Table 4.2:	Effective Conductivity Using Method #2	27
Table 4.3:	Effective Conductivity Using Method #3	28
Table 4.4:	Canister Heat Output as a Function of Decay Time	29
Table 4.5:	Canister Centerline-to-surface Temperature Drop, °C	31
Table 5.1:	Properties of Select Metals	35
Table 6.1:	Borehole Drilling Costs	48

LIST OF FIGURES

Figure 3.1:	Repository Layout	16
Figure 3.2:	Spent Fuel Canister Design	17
Figure 5.1:	Gallium-Zinc Melting Point	39
Figure 5.2:	Cadmium-Zinc Melting Point	40
Figure 5.3:	Magnesium-Tin Melting Point	41
Figure 5.4:	Magnesium-Zinc Melting Point	42
Figure 5.5:	Copper-Tin Melting Point	43
Figure 5.6:	Aluminum-Tin Melting Point	44
Figure 5.7:	Tin-Zinc Melting Point	45

CHAPTER 1. INTRODUCTION

Perhaps the single most important reason for opposition to nuclear power at present is the lack of progress toward disposal of its high level radioactive waste. Most of this waste is in the form of commercial spent nuclear fuel. According to a spent fuel database [1] established for evaluating the need for away-from-reactor (AFR) storage, expected AFR storage requirements will be from 5000 – 9300 metric tons heavy metal (MTHM) by the year 2000, and will increase at a rate of about 1000 – 2000 MTHM per year thereafter, depending on how many nuclear power plants will be operating at the time. According to the Nuclear Waste Policy Act of 1982, the United States Department of Energy (DOE) is required to start accepting excess spent fuel from nuclear reactors by the year 1998 [2]. The most feasible way to dispose of the fuel permanently is through underground burial in a geologic repository. Current plans call for building a 72,000 MTHM repository at Yucca Mountain in Nevada.

Interim Fuel Storage

While the U.S. is currently committed to building an underground repository at the Yucca Mountain Site, continuing administrative, political, and legal delays have pushed back the date for its opening. As evidenced by the database projections, the problem of storing the excess spent fuel becomes greater with time. To alleviate the

problem created by the delays, one possible short-term alternative would be to store the excess spent fuel at an above-ground site where it could be monitored and stored until a permanent repository became a reality. This monitored retrievable storage facility (MRS) would provide a place for the DOE to store the accumulated spent fuel acquired starting in 1998 until it could safely be placed in an underground facility.

Another reason it might be beneficial to store spent fuel at an MRS is the possibility of a reprocessing cycle. Though spent fuel is not currently reprocessed into new fuel in the U.S. as in other countries, such an option has been discussed in this country. Once the spent fuel is placed in the repository it would be difficult and costly to retrieve the fuel were reprocessing to become a reality. Delaying permanent storage of the fuel and storing it temporarily where it could be retrieved would provide a good source of fissile and fertile fuel material were the reprocessing cycle adopted in the U.S.

Criteria for Permanent Storage

In disposing the fuel underground, the biggest concern is whether or not the package form will remain intact over a long period of time. Should the packaging and fuel cladding be breached, ground water might carry radioactive material from the spent fuel to surface waters. Were enough radioactivity carried to the surface waters to create radioactive concentrations in the water sufficiently above normal, this would create a hazard to the public, rendering the water unsafe for public consumption or use. A small fraction of the initial radioactivity in the spent fuel comes from radioisotopes with half-lives of thousands of years, so as insurance against their release it is desirable to design a spent fuel disposal canister that will remain intact for this

length of time.

Current designs for spent fuel canisters call for consolidating the rods from 6 or 12 fuel assemblies into a close-packed array of fuel pins. These canisters were designed to keep the temperatures in the canister below a 375 °C limit above which stress rupture of the fuel cladding could occur. The canisters are also provided with enough shielding to reduce the surface exposure rates to acceptable limits. Although the canisters appear to be well designed, pessimistic critics suggest that the canisters might break or corrode over a long period of time, permitting groundwater leaching of the spent fuel to occur.

Proposal for Metal-filled Canisters

Because of this possibility, we have chosen to look at a possible alternative waste form concept: metal-filled spent fuel canisters. This alternative design would utilize the current designs for spent fuel canisters, but would add a metal filling in the canister to surround the fuel pins. This would likely be done by taking a canister of current design characteristics and filling it with a selected liquid metal. The fuel rods would be lowered into the canister, allowing the liquid metal to fill the spaces in the canister completely. Then the canister would be cooled and the filling metal would solidify. After this, the canister could be placed in an MRS or sealed and emplaced in a repository. The added metal would provide a distinct advantage over current designs economically, thermodynamically and mechanically, and most importantly, it would provide an added barrier against groundwater leaching of the spent fuel.

While current designs meet the proposed thermal limits, adding a metal filling would decrease temperatures in the canister due to the higher thermal conductivity

of metal as compared to the filling gas it replaces. Lowering the temperature even further throughout the canister would provide an added safety margin against stress rupture of the cladding. In addition, it might allow for an increase in the number of assemblies that could be placed in a canister. By adding more assemblies per canister, the number of canisters needed would be reduced, which in turn reduces the amount of space needed in the MRS or the hole-drilling in the repository. Both of these factors would lead to a decrease in the overall cost of storage of the spent fuel.

Another major reason metal filled canisters might provide an advantage over air-filled ones is due to the exclusion of air in the canister. The reason that it might be beneficial to exclude the air is that oxidation of the fuel would be precluded. The fuel is made of UO_2 which is a ceramic. Were oxygen in the air to diffuse into the fuel pin, it might react chemically with the fuel. Oxidation of UO_2 forms the product U_3O_8 . While UO_2 has a density of 10.5 g/cm^3 , U_3O_8 has a density of only 8.35 g/cm^3 . This decrease in the density of the fuel form would lead to a swelling of the fuel pellets. This in turn could lead to stresses upon the cladding by the fuel that might possibly lead to rupture of cladding. By excluding air from being able to diffuse into the fuel pins, the possibility of this occurrence is negated.

In addition to the above advantages of the new waste form concept, the metal filled canister might also provide further advantage in terms of mechanical stability and radiation shielding. While current canisters are designed to withstand lithostatic forces present in a repository, adding metal between the fuel pins would only add to their stability by making them behave as basically one solid mass instead of several long thin elements. Also, the radiation levels at the surface of the canister would be decreased due to the added shielding the metal would provide. Though

the change might be small, any decrease in radiation exposure to workers would be highly beneficial.

Perhaps the greatest benefit metal-filled spent fuel canisters would have is as an added barrier against groundwater leaching. Even under the most pessimistic estimations, it will take groundwater several hundred years to be able to break through the canister itself and then the fuel pin cladding to come in contact with the fuel. By adding another barrier consisting of a noncorroding metal for the groundwater to dissolve away before reaching the fuel, the amount of time required for this contact to occur would be greatly increased. Moreover, once groundwater did come into contact with the fuel, the amount of groundwater flowing through the fuel would be smaller because of the added barrier of metal. The smaller the groundwater flow, the less is the likelihood that unsafe limits of radioactivity might reach the above ground environment. While it remains to be seen what the magnitude of this improvement against groundwater leaching is, it would definitely be an improvement over current canister design and any improvement in canister design makes it easier to achieve public acceptance.

Possible Drawbacks

Initially, it was foreseen that a couple of drawbacks might be encountered by this new waste form design. These are the added weight to the canister and the added cost of the metal to be added to the canister. However, upon further study it appears that these will not be a problem. Since the fuel rods are close packed, the fuel pins take up a large percentage (about 75%) of the available space in the canister. Since a small amount of space will actually be filled by the metal, the weight of the package

will only increase about 25%, excluding the weight of the canister itself. Therefore the overall percentage weight increase will actually be small. Because the amount of metal added to each canister will be small, the cost of buying the metal should not be extremely large. While this is an increased cost, the likely savings due to other considerations will probably outweigh this cost. The major cost savings would come once the canisters were emplaced into a repository. Currently, it is proposed that each canister would be placed in a borehole in the repository floor and surrounded by an overpack material and a Ti metal lining. Because, in the new waste form, the choice metal would serve as a substitute to the lining and overpack, one or both of these could be eliminated. This would create a major savings, especially in the case of the metal lining. Also the drilling costs would decrease because less material would have to be removed.

The choice of material for the metal filling is the most important factor in the design of the new fuel canister. As mentioned previously, the metal chosen must be of low density, low cost, low melting point, high thermal conductivity, and be a good inhibitor against corrosion by groundwater. Of these factors, low melting point and prevention against corrosion are the most important. The melting point should optimally be below the 375°C temperature limit for cladding breach. Although the metal will be liquid for only a short time, it would be best if while in this state it did not exceed the stress rupture thermal limit, so as to eliminate any possibility of it occurring. Also, since the biggest objective of the new waste form is as another defense against groundwater leaching of the fuel, it would be best to choose a metal which shows strong resistance against corrosion by groundwater. These

parameters vary for different metals, and an analysis will be done, appropriately weighing the different criteria, to determine the optimum metal to be used in the design.

CHAPTER 2. LITERATURE REVIEW

The amount and type of nuclear waste generated from nuclear power is largely a function of the type of fuel cycle used. There are two basic fuel cycles with slight variations in each. The once-through cycle is known as such because after the fuel has been optimally used in the reactor it is disposed of as spent fuel. The alternative cycle involves taking the spent fuel and reprocessing the uranium and plutonium into fuel form to be reintroduced to the nuclear fuel cycle [2, 3, 4]. This reprocessing cycle obviously requires much less natural uranium input than the once-through cycle, but there is also the added cost of reprocessing the spent fuel into a suitable fuel form. In general, this cost is compared to the cost of storage in the once-through cycle as a means of determining which cycle is preferable. There is also concern that a reprocessing plant would have large amounts of plutonium on hand, which if diverted could be used to arm nuclear weapons [5].

Use of Reprocessing Cycle

Worldwide, a majority of the nuclear power producing countries use reprocessing, either domestically or through shipping spent fuel to a country that has reprocessing capabilities. Only Canada, Sweden, and the United States, do not use reprocessing. All three countries are currently working on building geologic repositories which would

permanently store the spent fuel underground and provide a buffer to release of radioactive waste to man [6, 7].

The once-through cycle was not always the choice for the United States nuclear fuel industry. In the past, the reprocessing cycle was thought to be the better alternative to immediate disposal of spent fuel. Commercial reprocessing was even done in a small scale at a plant in West Valley, New York, that was in operation from 1966 to 1972. In the years that followed, political and economic pressures forced the United States nuclear industry into adopting the once-through cycle, and so the situation remains today. It appears uncertain whether or not this will remain the case, and, if reprocessing is reintroduced to this country, when it would occur. Such a decision is not entirely improbable, however, considering the decrease in natural uranium requirements it would produce, as well as possible other economic advantages [4, 8].

United States Spent Fuel Storage

Although the United States has committed itself for now to the once-through cycle, political circumstances have caused delay in the construction of a geologic repository. Under the Nuclear Waste Policy Act (NWPA) of 1982, procedures for selection of a disposal site were outlined and a deadline of 1998 was set as a time the Department of Energy (DOE) would begin accepting the spent fuel from commercial reactors. At that time, 9 sites were chosen as possibilities for a repository. This was later reduced to 3 sites which were chosen based on their advantages as suitable mediums for a geologic repository. After environmental impact studies of the 3 sites, one site, Yucca Mountain in southern Nevada, was chosen as the site of the future repository. Yucca Mountain consists of a welded tuff material, and was chosen in

part because of its isolation from any nearby groundwater sources. Currently, underground testing at the site is taking place to ensure that it will behave properly as an underground repository. The consensus is that when a repository for spent fuel or waste is opened, Yucca Mountain will be the site of the repository[9].

Until a repository is constructed and operation commenced, the spent fuel generated in reactors in the United States will have to be accommodated by the individual reactors. In general, this is accomplished through storage of the spent fuel in a pool at the reactor site. However, many of the reactors in the United States have been operating for 20 years or more. Because of this, the remaining storage space left in these reactors is a major concern. Several reactors have already exceeded their capacity, even when measures have been taken to increase the capacity of the pools by consolidating the fuel rods[10, 11]. Because permanent storage in a geologic repository is not yet a reality nor likely to become one for at least 15 years, the amount of excess capacity spent fuel will become an ever greater problem. Projections have been made that show that the amount of away-from-reactor (AFR) storage required by the year 2000 will be from 4600 - 18000 metric tons of heavy metal (MTHM) in spent fuel. This large variation is due to the different scenarios possible. At the high end, the assumption is that storage of spent fuel at reactor pools will continue at current pace with no measures taken to maximize storage space in the fuel pools. By taking measures to increase storage capacity through consolidation or shipment of excess spent fuel to reactors with available fuel pool space, the amount of required AFR storage space decreases. The low value in the above projection represents a scenario where new reactors would be constructed in the next 10 years and would be able to host excess spent fuel from other reactors since the new fuel pools would

have nearly empty fuel pools. The low value might also pertain if and as incremental "dry storage" of older spent fuel at the reactor sites is implemented [1, 10].

Using a conservative assumption from the projections of no new reactors and no extended burnup of fuel, the cumulative AFR storage requirements are expected to be about 7300 MTHM spent fuel by the year 2000. The storage requirement is expected to increase at a rate of about 1800 MTHM per year thereafter, necessitating steps be taken to accommodate all this excess fuel until a repository begins operation [1].

Monitored Retrievable Storage

It was originally planned to transport spent fuel from the reactors directly to the geologic repository. Because construction of a repository has been continually moved back, the utilities have been saddled with what to do with the excess spent fuel on their hands. The proposed solution receiving the most support is to store this excess spent fuel at an AFR monitored retrievable storage (MRS) site. The idea is that the excess spent fuel could be stored at a single location and monitored until it became possible to move the fuel, either to a constructed repository or a reprocessing plant should that option be adopted in the future[12, 13].

Although wet storage of spent fuel has been done for many years and is a well-known process, dry storage of spent fuel is now the generally preferred concept. A comparative analysis was performed for the DOE and determined that AFR storage could best be accomplished by dry cask storage, with drywell storage as the most feasible alternative [14, 15, 16, 17, 18].

This process would be accomplished by consolidating the fuel rods into a canister

while in the spent fuel pool. This canister would then be placed into a shipping cask for transport to an MRS site. In order for a shipping cask to be approved by the Nuclear Regulatory Commission (NRC), the cask must be able to pass four tests. These tests are a 30 foot drop of the cask on an unyielding surface, a 40-inch drop onto a 6-inch diameter pin, followed by exposure to fire at 1475°C for 30 minutes, and a 24-hour immersion in water [5]. These tests simulate possible conditions in an accident that could possibly occur during transportation of the fuel. To date, several shipping cask designs have been tested and met approval by the NRC [19].

The general assumption for storage at an MRS site is that the fuel will have undergone a minimum of five years cooling. The storage casks so far designed are completely passive in operation and should require no maintenance. Heat rejection will be accomplished by convection and radiation through the surrounding air. Expected cladding temperatures will remain below 250°C and doses at the surface of the cask are designed to fall below 20 mrem/hr by inclusion of a solid neutron shield in the cask. The casks are also designed so as to allow loading of the fuel into the cask at the reactor fuel pool which minimizes the exposure to those handling the cask [14, 16, 17].

Repository Storage

Eventually, the fuel at the MRS site will have to be removed and either reprocessed or transferred to a repository for permanent storage. Storage of the spent fuel in the repository will be accomplished in much the same manner as in dry storage. Canisters have been designed for emplacement in a repository. When designing such canisters, certain criteria must be maintained to ensure the integrity of the canister.

The major objective for long term underground storage is to prevent groundwater leaching of the fuel for as long as possible. Since a majority of the radioactive nuclides generated during reactor burnup remain in the UO_2 fuel matrix, the fuel cladding is the first buffer separating the fuel from groundwater attack [19]. In order to prevent the cladding from cracking and ultimately failing, it is important to keep the temperatures in the canister below 375°C , which is where stress corrosion cracking of Zircaloy cladding can occur [2, 11].

Another possible concern is possible cladding failure that could occur because of the presence of oxygen in the air between fuel rods. When oxygen diffuses through minute apertures in the cladding, it can react with fuel and oxidation occurs, generally at temperatures above 250°C . Upon oxidation of UO_2 , with a theoretical density of 10.97 g/cm^3 , a final state of U_3O_8 is produced, having a density of 8.38 g/cm^3 . This decrease in density results in an increase in the volume of the fuel, which can crack the surrounding cladding open and rid the fuel of its initial barrier to contact with groundwater [2].

Metal Filled Canisters

Most designs for canister storage in a repository consist of an air-filled, consolidated-rod spent fuel canister surrounded by an overpack, and possibly a sleeve, which in turn is surrounded by a backfill material which lies between the canister and the host rock. The material most often selected for this task is bentonite, a clay that swells when it absorbs water. This fills up all the space between the canister and host rock, creating a plastic zone with very low hydraulic conductivity. This acts as a retardant to water entry to, or radionuclide leakage from, the canister borehole.

Although the bentonite is another good buffer between the fuel and the groundwater, the cost of the bentonite is rather high. Because of this and other considerations, it was decided to look at the possible effect metal filling of the spent fuel canisters might have on canister performance [4, 13, 20].

By filling the air-filled cavity in the canister with a liquid metal and allowing it to cool and solidify, another buffer would be produced. This could allow elimination of the bentonite buffer, and could create a possible savings in the overall cost of the storage. This study looks at what benefits metal filling the canisters might have as well as any possible detrimental effects. These considerations consist of the better heat conduction of the metal and therefore lower temperatures in the canister, as well as the elimination of oxygen in the canister which should prevent oxidation of the fuel. There is also the possibility that the metal-filled canisters could be used to store fuel at an MRS site until a repository finally begins operation. Then should reprocessing become a reality, the spent fuel could be removed from the metal-filled canister and used to produce new fuel. When these and other advantages are weighed against any disadvantages, an overall analysis can determine whether such a concept would be more feasible than the current designs, both technologically and economically.

CHAPTER 3. SPENT FUEL CANISTERS

This chapter describes the technology and designs currently used for spent fuel canisters, as well as a description of how metal-filling these canisters might be accomplished. While a metal-filled canister appears to be a new idea requiring a whole new design, the creation of such a canister should be able to be accomplished with little or no changes over the designs now being used.

Once a repository is finally constructed and begins operation, storage of spent fuel will be accomplished by filling a metal canister with spent fuel rods from several reactor assemblies and emplacing this canister in the underground repository for permanent storage. The repository itself will consist of several corridors accessed from a central shaft area, with adjoining rooms between corridors. Within these rooms, as shown in Figure 3.1, are several boreholes [13]. The spent fuel canisters are emplaced in these boreholes, surrounded by an overpack material and possibly a fission-product retarding material such as bentonite, and covered with a crushed rock for permanent storage. A generic description of this is shown in Figure 3.2 [20].

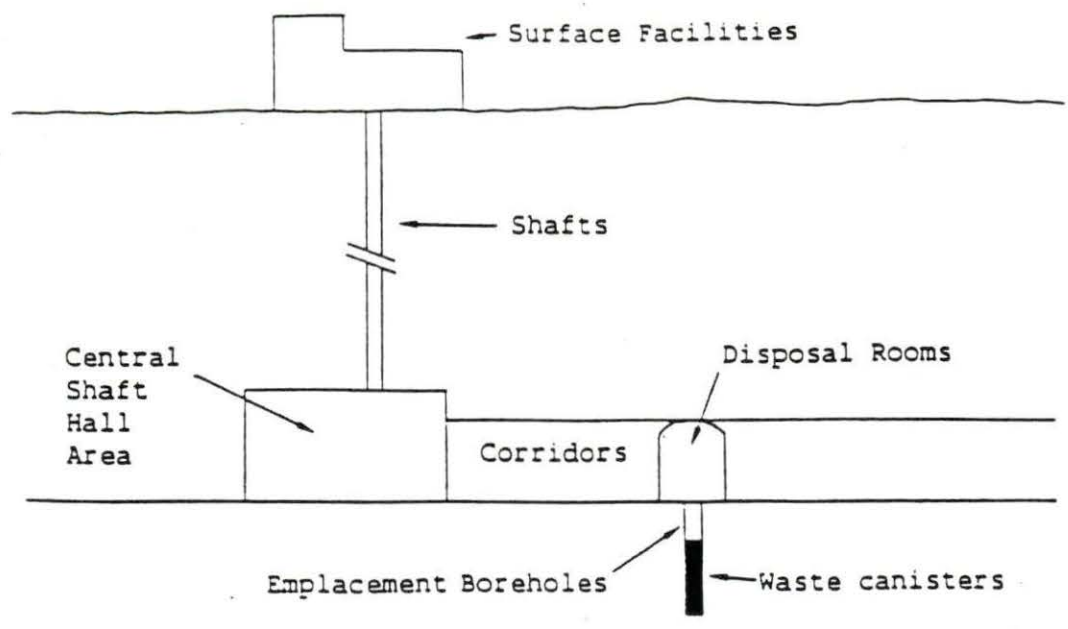

VERTICAL SECTION

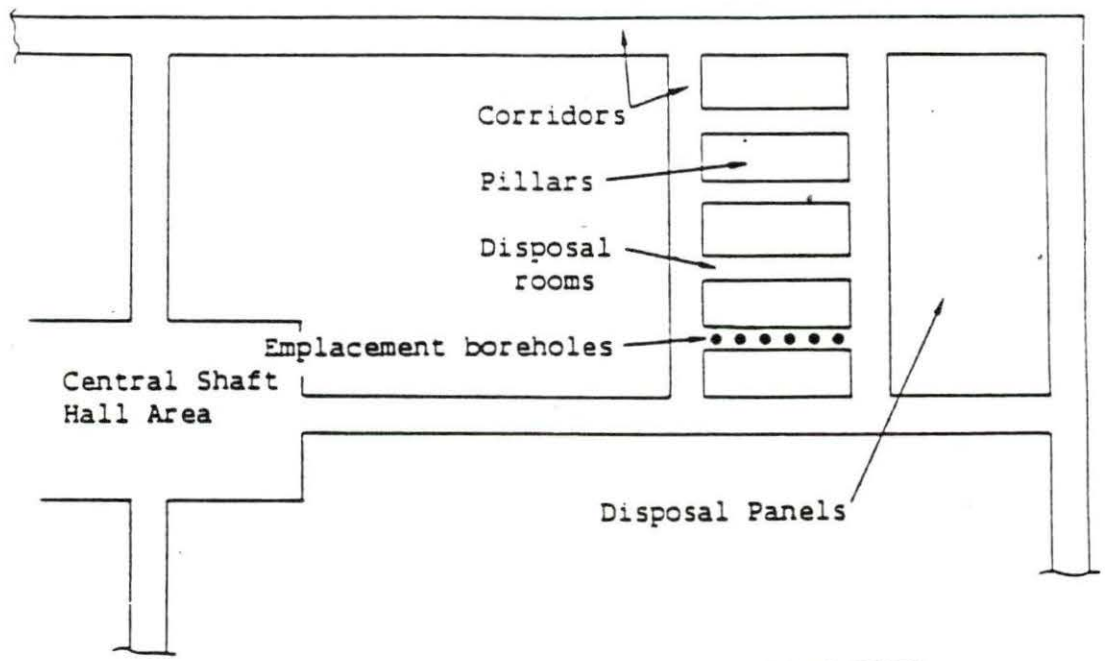

PLAN VIEW

Figure 3.1: Repository Layout

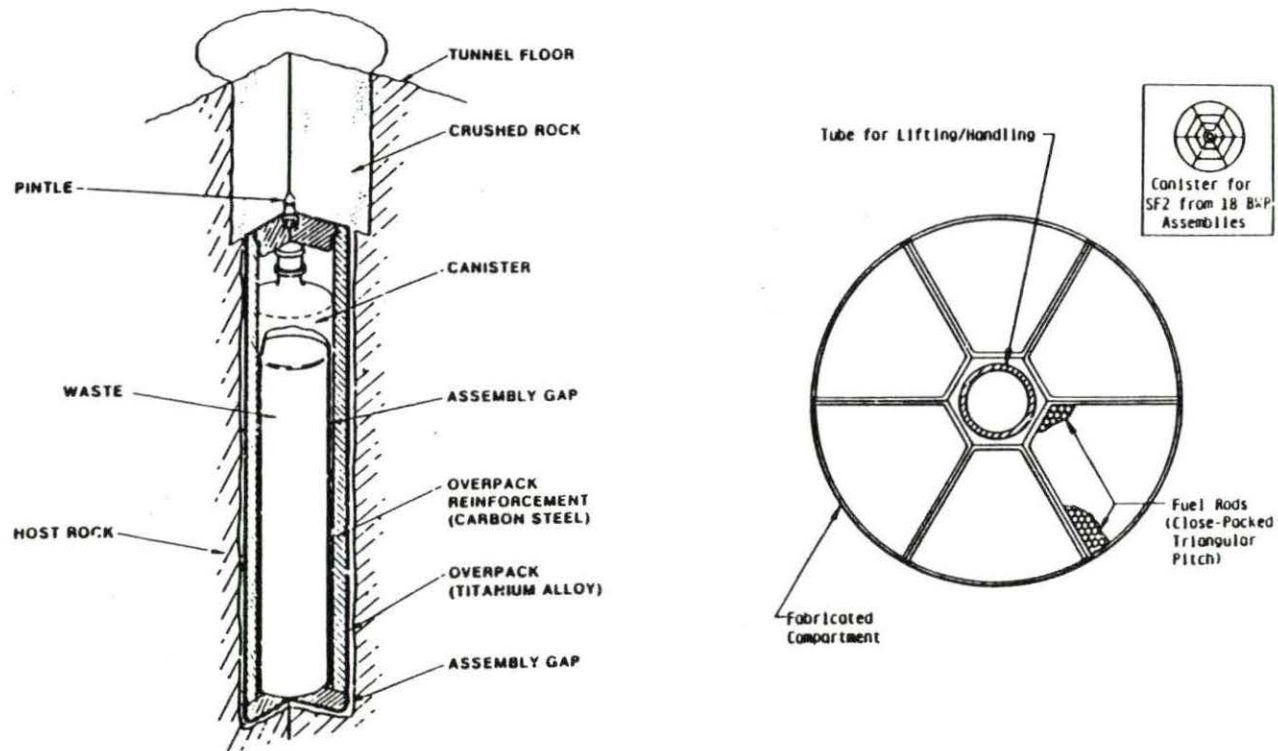

Figure 3.2: Spent Fuel Canister Design

Reference Canister Design

Although several designs exist for spent fuel canisters, most are essentially the same with some slight modifications. For this study, a reference canister design was used, taken from a study performed by Battelle Memorial Institute on spent fuel canister storage in tuff [20]. Although this study deals only with the PWR design, we can assume that what is true for PWR storage can similarly be accomplished for BWR storage with appropriate minor modifications.

The reference design is a canister that contains 2766 kg of uranium, which is equivalent to the spent fuel from 6 reactor assemblies. These fuel rods are stored vertically in 6 sections within the canister, as is shown in Figure 2. The 3300 W thermal power of the canister represents spent fuel that has cooled for 10 years. These assumptions were used as a basis for the design of the metal-filled canister, which is just a modification of current gas-filled canisters [20].

The purpose of the metal filling is to exclude oxygen from entering the canister, improve mechanical stability, and improve the thermodynamics of the current canister. This is best accomplished by minimizing the size of the canister. Given that current designs use a close-packed array of fuel pins, creating the smallest canister size possible, no changes in the dimensions of the canister will need to be made for the metal filling.

Methods of Filling Canister

In order for the canister to have a metal matrix surrounding the fuel pins, the metal will need to be in a molten state while the pins are put into the canister and

then cooled to form a solid metal filling. This can be accomplished in several ways. One possibility would be to have the fuel pins already consolidated in the canister and to place spacers made of the specified metal between the rods. The canister could then be heated as a whole, allowing the spacers to melt and fill the canister spaces with metal, whereupon it could be cooled. The problem with this method is in the use of the spacers. Because of the small size of the spaces between fuel rods, spacers of specific dimensions would have to be fabricated. This fabrication process is an added cost to the process that could be eliminated using another method.

Instead of using costly spacers in the canister with the rods already present, a better method would be to pour the molten metal into the canister. The choice metal could be heated until complete melting occurred and this could be poured into the canister until all space between rods was occupied by the metal. The whole package would then be cooled until solidification of the metal filling occurred.

Because it would take some time to fill the canister with the molten liquid, the canister would have to be heated, along with the container from which the metal was being poured, to avoid letting any of the metal solidify before the process was complete. This involves heating and monitoring the temperature of two separate components in the metal filling process. One way to eliminate this would be to just heat a canister containing the appropriate volume of metal needed for filling. The fuel rods could then be lowered into this liquid metal, causing the metal to rise and surround the fuel pins. Then the whole canister could be cooled to form the final metal-filled product.

Of the three suggested methods, the last one appears to be the best. It is the quickest and cheapest method of the three. Regardless of the method chosen for

metal filling, the filling of the canister should be an achievable process. Using current canister designs and choosing an appropriate method of filling should provide for a metal-filled canister that is easily manufacturable.

CHAPTER 4. THERMAL ANALYSIS

The purpose of the thermal analysis is to determine the temperatures within the spent fuel canister. This is done to show that the 375°C limit is not violated by the reference design and also to determine if more assemblies could be added per fuel canister without violating this limit. In either case, the calculation of the maximum temperature in the canister is not a simple one. The canister contains several different materials, each distributed evenly throughout the inside of the canister but not in a manner for easy thermal analysis. While determining the temperature of a cylinder is a simple enough task, this case essentially involves a cylinder full of smaller cylinders, with the irregular area remaining filled with another material. Representing this entire geometry in either cylindrical or Cartesian coordinates becomes an extremely tedious task. Because of this, two other methods are used employing treatment of the different materials as a single homogeneous mixture.

Generic Canister Analysis

The spent fuel canister temperature distribution can best be represented as a cylinder with uniformly distributed heat sources and a single thermal conductivity. Though this is a less than ideal representation of the actual canister configuration, it provides a good estimate by treating the different material regions as a homogeneous

mixture with a single thermal conductivity value. This is a reasonable approximation because the various material constituents are evenly distributed throughout the canister and the arrangement of materials in one region of the canister does not significantly differ from that of another.

Using this argument creates a much simpler solution for the temperature in the canister. The one-dimensional heat conduction equation for a cylinder with uniformly distributed heat sources is given by [21, 22, 23]

$$\frac{d^2T}{dr^2} + \frac{1}{r} \frac{dT}{dr} + \frac{q'''}{k} = 0 \quad (4.1)$$

where q''' is the volumetric heat generation rate, and k is the overall thermal conductivity of the cylinder. When the appropriate boundary conditions are applied and the above equation is solved, the temperature drop from centerline to surface of the cylinder is written as,

$$dT = \frac{q''' R^2}{4k} \quad (4.2)$$

with R being the outer radius of the cylinder. Since both the dimensions of the cylinder and its heat generation rate are known quantities, this solution becomes complete through knowledge of the overall effective thermal conductivity.

Method #1 Analysis

One method used to estimate the effective conductivity is to weight the conductivity values of the individual components volumetrically. For the spent fuel canister this is done by separating the canister into two regions, the spent fuel rods and the metal filling. While a spent fuel rod consists of ceramic fuel, an air gap, and metal

cladding, it too can be represented by an overall thermal conductivity value, represented by k_{rod} . The temperature drop from the center of a fuel rod to its surface is given by [24]

$$T = \frac{q'}{2\pi r_f} \left(\frac{r_f}{2k_f} + \frac{1}{h_g} + \frac{t_c}{k_c} \right) \quad (4.3)$$

$$\text{where } q' = q''' \pi r_f^2$$

r_f = fuel radius

t_c = clad thickness

k_f = thermal conductivity of fuel

h_g = gap conduction value

k_c = cladding thermal conductivity

When this is equated to a cylinder with uniform heat conduction, the overall thermal conductivity coefficient is given by [5, 8, 24]

$$\frac{1}{k_{rod}} = \frac{2r_f}{R^2} \left(\frac{r_f}{2k_f} + \frac{1}{h_g} + \frac{t_c}{k_c} \right) \quad (4.4)$$

The values used for a standard fuel rod are given below, along with values for gap conductance and fuel and clad conductivity [5, 8, 25].

$$r_f = 0.4095 \text{ cm}$$

$$R = 0.475 \text{ cm}$$

$$k_f = 0.072 \text{ W/cm}^\circ\text{C (95\% density, 100}^\circ\text{C)}$$

$$= 0.084 \quad " \quad (200^\circ\text{C})$$

$$h_g = 0.5 - 1.1 \text{ W/cm}^2\text{°C}$$

$$k_c = 0.16 \text{ W/cm}^{\circ}\text{C}$$

$$t_c = 0.057 \text{ cm}$$

Using the lower end values for gap conductance and fuel conductivity to evaluate the overall thermal conductivity gives a value for k_{rod} of $0.053 \text{ W/cm}^{\circ}\text{C}$. This is lower than the conductivity values of both the fuel and cladding material and reflects the thermal resistance of the gap. Since the clad and fuel make up a major portion (97%) of the fuel rod, the heat transfer through fuel rods in the canister will be mostly through these materials. Since the overall heat transfer coefficient is lower than both of these conductivity values, it appears this value will provide a reliable conservative estimate.

The first estimate of the temperature drop across the canister was done using a volumetric averaging of the different materials in the canister. The canister is treated as consisting of two heterogeneous regions and thus can be treated in a similar manner as the fuel rod was in determining an overall heat transfer coefficient. In this case, the two regions are the fuel rod regions and the metal filling region. The temperature drop for this geometry can be found by treating the heat transfer geometry as a slab of two independent materials, the fuel rod region and metal region. For this geometry, an overall heat transfer coefficient can be found by [23]

$$k_c = \left(\frac{x_r}{k_r} + \frac{x_m}{k_m} \right)^{-1} \quad (4.5)$$

where k_c = Overall conductivity of cylinder

k_r = Overall fuel rod conductivity

k_m = Thermal conductivity of metal

x_r = Fuel rod volume fraction

x_m = Metal filling volume fraction

For the case of a canister containing 6 assemblies, the outer radius is 22 cm and the number of fuel rods is 1584, each having a radius of 0.475 cm. The volume fraction of the fuel rods is equal to 0.7384, with the remainder essentially metal filling. This is the case regardless of the number of assemblies per canister since the number of rods per unit volume is the same for all canister sizes. When the above equation was solved using various metals for the filling the following results were obtained.

Method #2 Analysis

The second estimation of overall heat transfer coefficient was taken from a report given at the Twentieth International Thermal Conductivity Conference given in 1987 [26]. The paper presented dealt with evaluating effective thermal conductivity of composites consisting of a continuous matrix phase interspersed with dilute concentrations of cylindrical, spherical, or flat plate dispersions. Although the fuel canister consists of a nearly continuous matrix containing highly concentrated cylindrical elements, the equations presented in the paper were used since they appeared to be a better approximation of the particular problem encountered in this research.

For a matrix containing circular cylindrical dispersions, the following equation was presented [26]

$$k_{eff} = k_m \frac{\left[\left(\frac{k_d}{k_m} - 1 - \frac{k_d}{ah_c}\right)v_d + \left(1 + \frac{k_d}{ah_c} + \frac{k_d}{k_m}\right)\right]}{\left[\left(1 + \frac{k_d}{ah_c} - \frac{k_d}{k_m}\right)v_d + \left(1 + \frac{k_d}{ah_c} + \frac{k_d}{k_m}\right)\right]} \quad (4.6)$$

k_{eff} - Effective thermal conductivity

k_d - Dispersion conductivity

k_m - Matrix conductivity

v_d - Volume of dispersion

a - Radius of dispersion

h_c - Boundary conductance due to
interfacial thermal barrier

All of these values are known except the boundary conductance. In the ideal case where there is perfect contact between the fuel pins and the metal filling the boundary conductance is infinite and the above equation reduces to a solution that agrees with Rayleigh's solution for the ideal case. Since there will likely be small imperfections in the contact between the two surfaces, due to fuel pin roughness and shrinkage of the metal filling due to cooling, the boundary conductance value should be less than infinite. Since it is impossible to determine the exact value of the conductance, the convective value of $0.5 \text{ W/cm}^2\text{C}$ for heat transfer through the fuel rod air gap was used as a lower bound for the probable conductance value. The results for the effective thermal conductivity for both the ideal case and lower bound case for some select metals are shown in Table 4.2.

Table 4.1: Effective Canister Conductivity, Method #1

<u>Metal</u>	k_m <u>[W/cm°C]</u>	k_c <u>[W/cm°C]</u>
Cu	3.74	.0714
Al	2.04	.0711
Mg	1.52	.0709
Zn	1.06	.0705
Cr	0.85	.0702
Sn	0.57	.0695

Table 4.2: Effective Conductivity Using Method #2

<u>Metal</u>	k_m	$k_{eff}(h=0.5)$	$k_{eff}(h=1.0)$
Cu	3.74	0.605	0.614
Al	2.04	0.349	0.359
Mg	1.52	0.271	0.280
Zn	1.06	0.202	0.211
Cr	0.85	0.170	0.179
Sn	0.57	0.128	0.137

Table 4.3: Effective Conductivity Using Method #3

<u>Metal</u>	<u>k_m</u>	<u>k_{mat}</u>	<u>k_{eff}</u>
Cu	3.74	0.385	0.159
Al	2.04	0.366	0.153
Mg	1.52	0.353	0.150
Zn	1.06	0.332	0.143
Cr	0.85	0.317	0.139
Sn	0.57	0.285	0.129

Method #3

Another way to look at the spent fuel canister is to consider it as a metal matrix consisting of the metal filling and Zircaloy cladding, and containing a dispersion of fuel with an air gap. For this case the gap convection value of $0.5 \text{ W/m}^2\text{°C}$ can be used as the boundary conductance value in the matrix.

As was stated earlier, the effective conductivity of a two-material mixture (in this case, the Zircaloy and metal filling), can be determined by,

$$k_{mat} = \left(\frac{x_{Zr}}{k_{Zr}} + \frac{x_m}{k_m} \right)^{-1} \quad (4.7)$$

In a canister containing 6 assemblies, the volume fraction of cladding in metal is 0.389 and the dispersion volume fraction is 0.5488. The results for the effective thermal conductivity calculated employing this method are shown in Table 4.3.

As can be seen from Table 4.2, the gap conductance value has little effect on the effective heat transfer coefficient. The values determined from this equation also are significantly higher than the predictions offered by the first method. It is unknown

Table 4.4: Canister Heat Output as a Function of Decay Time

Decay Time (yrs)	Q (W/MT)	Q''' (W/cm ³)
10	1127.5	0.00571
20	812.5	0.00412
30	719.0	0.00364

which value gives a better approximation to the actual value so both were used in determining the temperature drop from centerline to surface of the cylinder.

Temperature Drop Analysis for Three Methods

In order to find the temperature drop across the canister it is necessary to determine the volumetric heat output of the canister, which is the same regardless of the number of assemblies per canister. For a canister containing 6 assemblies, with inner radius 22 cm and active heating height 366 cm, there is calculated to be 2.82 MTHM occupying the canister. For fuel that has been out of the reactor for 30 years or less, the equation is[13],

$$Q = 550 \left(\frac{1}{0.223 + 0.117 * t} \right) \quad (4.8)$$

t - years after removal from reactor

Since the fuel being stored in repositories will be at least 10 years old and initially 20 or 30 years old, these values were used to determine volumetric heat outputs for the different ages of fuel. These are given below:

The results for temperature drop across the cylinder are given in Table 4.5 for the case of 6 assemblies/canister and using three different ages of fuel and 3 methods of determining effective thermal conductivity.

The purpose of the thermal analysis of the metal-filled canister was to show that thermal constraints could be met by the canister. We assume that the repository environment will have a temperature of about 100°C . In order to maintain a temperature below the 375°C stress rupture limit, a temperature drop of less than 250°C must be maintained.

From the results shown in Table 4.5, it is easy to see that the largest calculated temperature drop for any metal, method, or decay time, is less than 10°C for a 6-assembly canister. It also shows that the choice of material will be more dependent on other metallic properties. It also appears that each of the three methods used to find the effective conductivity provide comparable results with method #1 the most conservative estimate.

The temperature drop across the assembly is proportional to the volumetric heat source times the square of the radius of the canister, as per equation 4.2. Since the volumetric heat source is just the total fuel rod heat output divided by the canister volume, the temperature drop is proportional to the number of fuel rods divided by the height of the canister. The canister height is not a variable that will be changed and therefore the canister temperature drop is linearly proportional to the number of fuel assemblies per canister. That is, a canister containing 12 assemblies will have twice the temperature drop as a canister containing only 6 assemblies, and likewise a canister with 24 assemblies will have four times the temperature drop of the 6-assembly canister.

Table 4.5: Canister Centerline-to-surface Temperature Drop, °C

<u>Metal</u>	<u>k_m</u>	<u>Method</u>	<u>k (W/cm^{°C})</u>	<u>10 yrs</u>	<u>20 yrs</u>	<u>30 yrs</u>
Al	2.04	1	0.0711	9.7	7.0	6.2
		2	0.349	2.0	1.4	1.3
		3	0.153	4.5	3.3	2.9
Cu	3.74	1	0.0714	9.7	7.0	6.2
		2	0.605	1.1	0.8	0.7
		3	0.159	4.3	3.1	2.8
Cr	0.85	1	0.0702	9.8	7.1	6.3
		2	0.170	4.1	2.9	2.6
		3	0.139	5.0	3.6	3.2
Mg	1.52	1	0.0709	9.7	7.0	6.2
		2	0.271	2.5	1.8	1.6
		3	0.150	4.6	3.3	2.9
Sn	0.57	1	0.0695	9.9	7.2	6.3
		2	0.128	5.4	3.9	3.4
		3	0.129	5.4	3.9	3.4
Zn	1.06	1	0.0705	9.8	7.1	6.2
		2	0.202	3.4	2.5	2.2
		3	0.143	4.8	3.5	3.1

In terms of the improved thermodynamic performance of the metal-filled canister it must be compared with that of the current gas-filled design. While the conductivity is a function of temperature, analyses have been done that estimate the conductivity of the gas-filled canister to be 0.85 W/mK at about 200°C [13]. For 10-year old spent fuel with 6 assemblies per canister, this yields a temperature drop across the canister of about 81°C. This is eight times higher than the results for the metal-filled canister. While this is not a significant temperature drop for the gas-filled canister, it would become one were the number of fuel assemblies per canister increased. If there were 18 assemblies per canister, this would create a temperature drop of about 240°C, which with an environment of about 100°C could create centerline temperatures in the range where stress rupture of the cladding could occur.

Because the temperature drop in a 6-assembly canister is less than 10°C, the number of assemblies per canister can be increased significantly and still maintain the thermal limits required. Theoretically, a canister could contain up to 25 times as many assemblies, or 150 assemblies, and still have a temperature drop of 250°C or less. Obviously other limits on canister size will come into play to determine the maximum size of the canister. Consideration to the weight of the canister, as well as ease of handling of the canister, will limit the size of the canister. The optimum size of the canister will best be decided by weighing these considerations against the savings incurred by including more assemblies per canister, which decreases storage and excavation space and cost.

The thermal analysis shows conclusively that the thermal criterion can be maintained easily for relatively all canister sizes. Because the temperature drop is relatively equal regardless of the metal selected as a filling, other considerations will be

important in determining the choice of metal. The size of the canister will also be determined by other factors such as the weight of the canister as it is balanced by savings incurred by enlarging the canister.

CHAPTER 5. CHOICE OF MATERIAL

In selecting a metal with which to fill the canister several important factors must be considered. These factors are related to the different advantages the metal is supposed to provide. Perhaps the most important advantage sought by the use of metal filling is as an added barrier to groundwater leaching of the spent fuel. The metal functions both to eliminate oxygen in the canister and provide a physical barrier to groundwater penetration.

The initial search for a suitable material to use in the canister centered around properties of individual metals. Ideally, the metal selected should be the one with the highest thermal conductivity, along with lowest density and cost. An initial comparison of these properties for a select group of metals is given in Table 5.1[22, 23, 27, 28, 29]. In terms of these properties, it is apparent that aluminum would be the best choice for metal filling. However, certain other conditions must also be considered.

Properties of Metals

The process of filling the canister with metal will involve having the metal in a liquid state while it is cooled to solidify around the fuel pins. Although this process will take little time, it is much preferred to keep the temperatures in the canister below

Table 5.1: Properties of Select Metals

<u>Metal</u>	<u>Symbol</u>	<u>Density</u> <u>(kg/m³)</u>	<u>k</u> <u>(W/m K)</u>	<u>M.P.</u> <u>(K)</u>	<u>Cost</u> <u>(\$/lb)</u>
Aluminum	Al	2.71	204	933	0.82
Beryllium	Be	1.85	218	1285	
Bismuth	Bi	10.01	16.4	544	
Cadmium	Cd	8.65	92	594	
Chromium	Cr	7.19	85	2130	
Copper	Cu	8.95	374	1358	1.35
Gallium	Ga	5.91	29	303	
Gold	Au	19.32	304	1336	6200
Indium	In	7.31	24	430	
Iridium	Ir	22.42	147	2723	
Iron	Fe	7.90	62.3	1809	
Lead	Pb	11.37	31.5	601	0.51
Magnesium	Mg	1.75	152	923	
Molybdenum	Mb	10.22	114	2890	
Nickel	Ni	8.91	72.7	1726	12.5
Potassium	K	0.81	45.0	336	
Rhodium	Rh	12.41	150	2238	
Sodium	Na	0.9	80.3	370	
Silver	Ag	10.53	374	1234	77
Tin	Sn	7.3	57	505	3.77
Tungsten	W	19.35	142	3680	
Uranium	U	18.7	31	1405	11.5
Zinc	Zn	7.14	106	693	0.87

the 375°C stress rupture limit for the cladding. If this is not done it is conceivable that some stress rupture of fuel pins might occur, thereby removing an important barrier, the cladding, to groundwater intrusion. Even though this possibility might seem unlikely, the possibility of its occurrence favors keeping the temperature below the 375°C limit, so that all of the fuel rods are initially intact upon emplacement in the repository. Because of this consideration, an upper limit should be set on the melting point of the selected metal. A limit of 350°C was chosen because this is far enough below the stress rupture limit of the cladding that the fuel should be unaffected by this phenomenon.

While the fuel canister is in the repository, one of the metal filling's main purposes will be to provide a suitable barrier against groundwater intrusion. In terms of the phase of the metal, it is more difficult for water to penetrate a solid metal by breaking it down through corrosion than it is for liquid metal to seep through cracks in the canister. Because of this, it is also necessary to have the temperature of the metal in the canister stay below its melting point during its lifetime in the repository. The fuel canister will experience its highest temperature upon emplacement in the repository when the decay heat output is highest. Therefore this requirement will be satisfied if the temperature of the canister at the outset of its repository life is below the melting point of the metal filling. As is shown in the thermodynamic analysis of the canister, the maximum temperature in the metal-filled fuel canister will be below 200°C. So, to eliminate the possibility of any melting of the metal due to higher than expected localized heat outputs, a lower melting point limit of 200°C was placed on the metal.

When the melting point limits were chosen, many of the metals were eliminated.

Among those eliminated by this criterion were aluminum and copper, both of which would have been strong candidates otherwise.

Table 5.1 also shows the melting points of the various metals looked at as possible choice materials. Some of the metals in the list, that have suitable melting points, unfortunately have other unsuitable properties, such as high density or low thermal conductivity that make them less desirable for a metal filling. Due to this fact it was decided that using an alloy might improve upon the properties of a pure metal while keeping a melting point that remains within the prescribed limits. Figures 5.1 through 5.7 contain several solid-liquid phase diagrams are given for various binary alloys.

Binary Alloys

Some of the alloys in the phase diagrams can immediately be eliminated for other reasons. The gallium-zinc alloy was eliminated due to an unusual property gallium has. Upon solidification from the liquid phase, pure gallium expands by 3.1% instead of shrinking [27]. While the effect should be less pronounced in an alloy, any expansion of the metal at all is undesirable because it will put stresses on the cladding that could lead to its failure. Moreover, gallium is expensive and poisonous.

The next phase diagram shown is for a cadmium-zinc alloy. This alloy has a suitable melting point for zinc concentrations from 0% to about 80%. However, cadmium is a rather toxic substance. This alloy was thus eliminated from consideration because should the canister be breached and the cadmium be carried out by the groundwater, its toxicity could have harmful effects upon the above-ground environment. For this

reason, lead was also eliminated from consideration.

The magnesium-tin and magnesium-zinc binary alloys were also eliminated from consideration because magnesium is readily attacked by neutral or acidic solutions of salts such as chlorides, bromides, and sulfates of all metals [30, 31]. Since the groundwater at the Yucca Mountain site contains significant amounts of both sulfates (22.0 mg/l) and chlorides (7.0 mg/l), and the groundwater is essentially neutral (pH 7.1), the use of magnesium metal in the metal filling is undesirable [20].

Conclusion of Metal Filling Selection

All of the remaining three binary alloys are suitable candidates as the metal filling material. In each case tin comprises a large fraction of the alloy. Obviously, the best choice for a metal filling is going to involve either tin itself or an alloy of tin. Tin is attacked by nearly all inorganic acids and by alkaline solutions with a pH above 10 [30, 31]. However, since the groundwater is neutral, tin should not be corroded easily. Nevertheless, some pitting is likely to occur because of the presence of chlorides, nitrates, and sulfates in the water. In order to improve upon its corrosion resistance, small quantities of bismuth or antimony could be added to the tin. These alloys would provide better corrosion resistance than alloys containing tin with either aluminum or copper, which tend to decrease the corrosion resistance of the tin.

The best possibilities for the metal filling remain the basic tin metal, a tin-zinc alloy, and "tin babbitt", which is an alloy containing tin, antimony, and copper [27]. These tin babbitt alloys contain various percentages of the three metals, and are readily available since they are often involved in the manufacture of bearings.

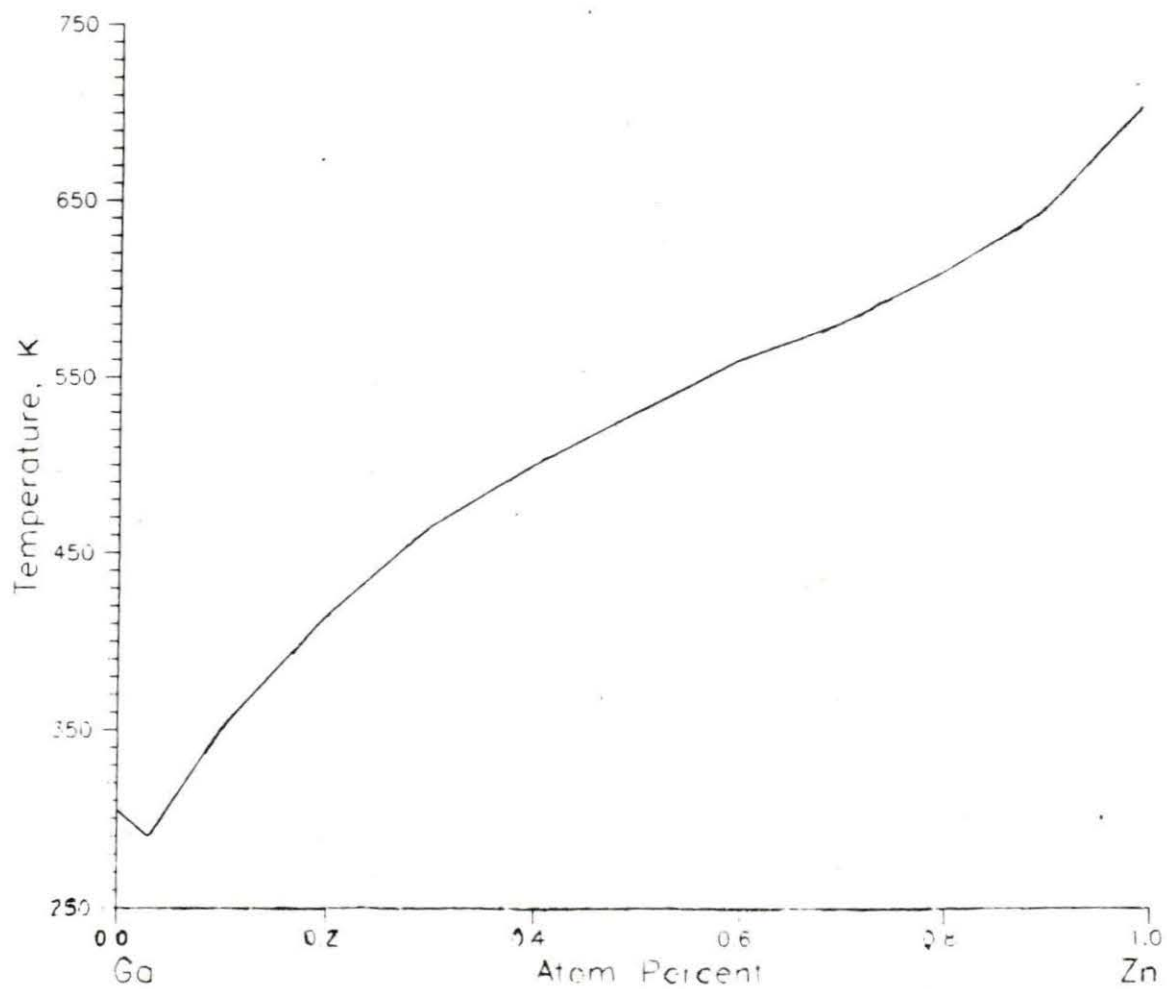

Figure 5.1: Gallium-Zinc Melting Point

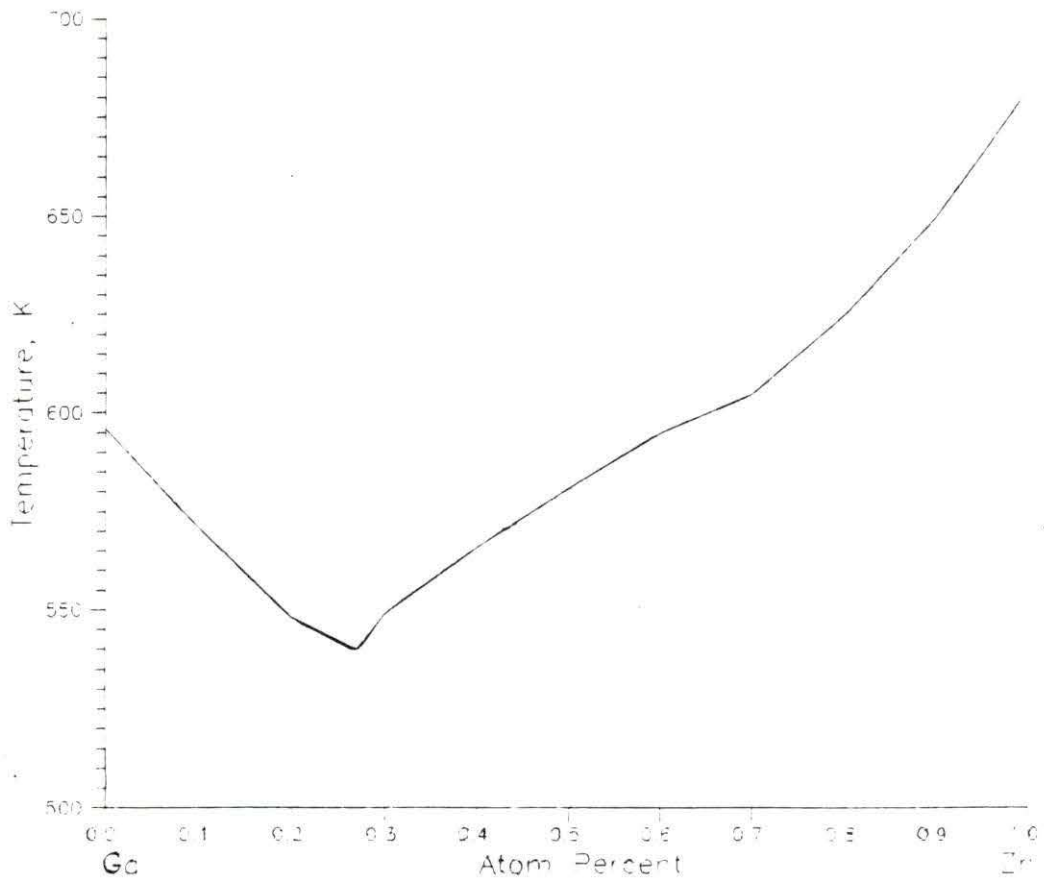

Figure 5.2: Cadmium-Zinc Melting Point

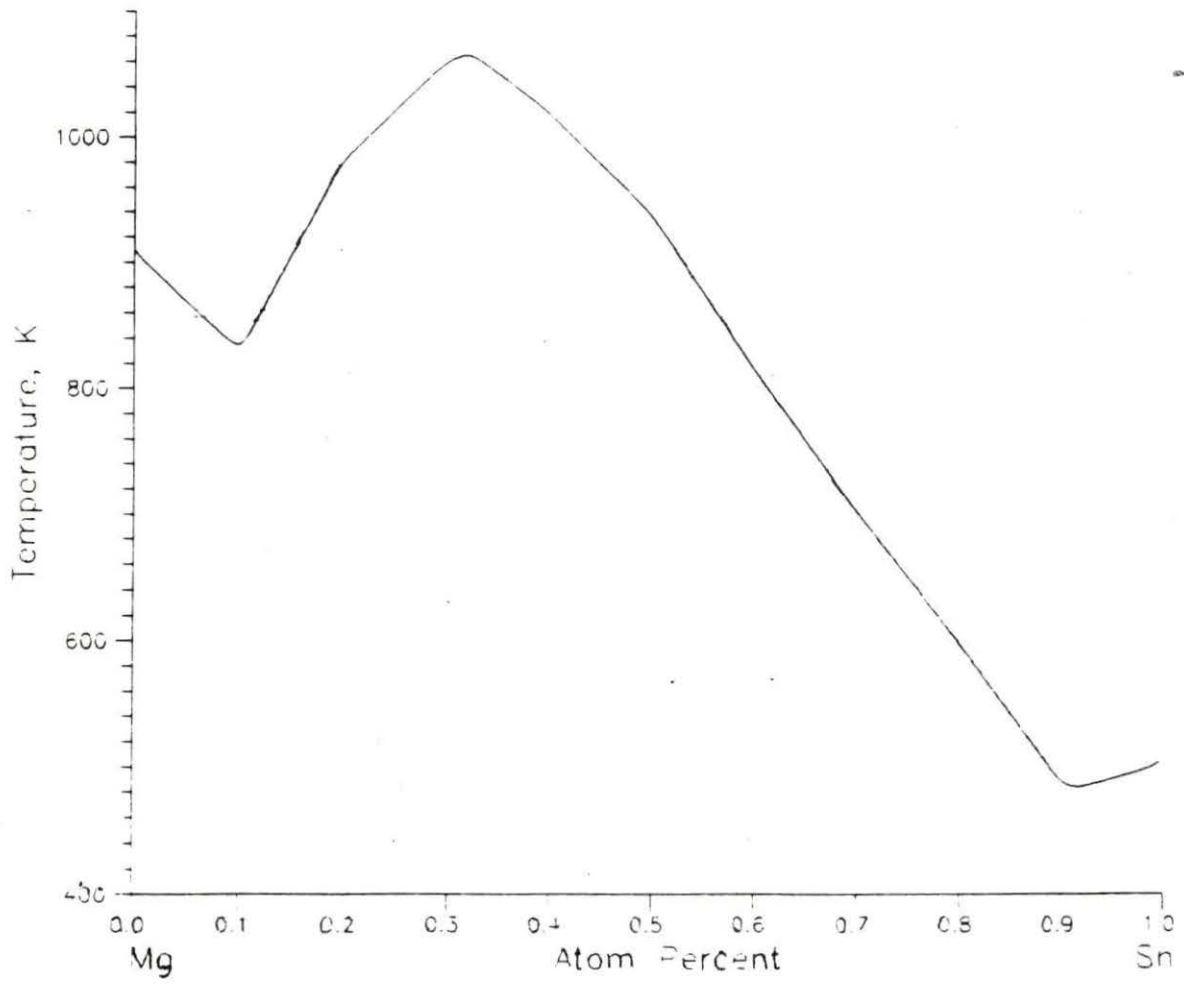

Figure 5.3: Magnesium-Tin Melting Point

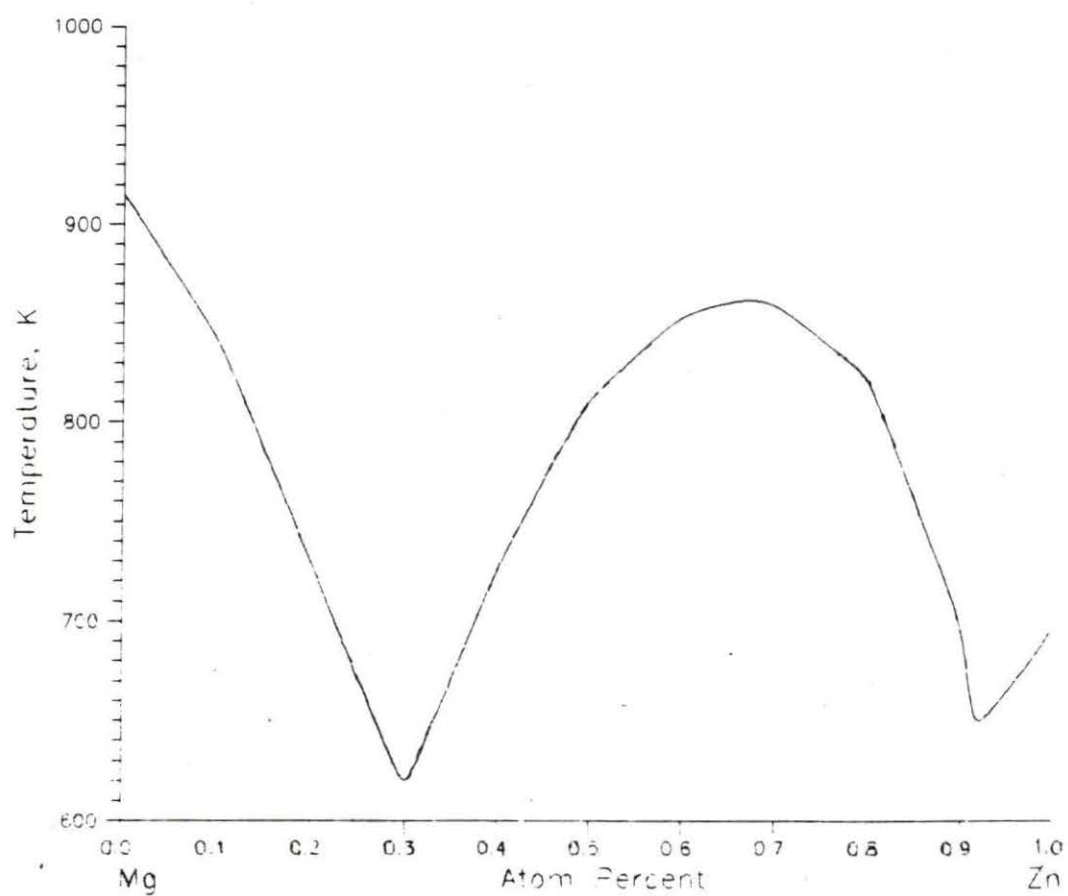

Figure 5.4: Magnesium-Zinc Melting Point

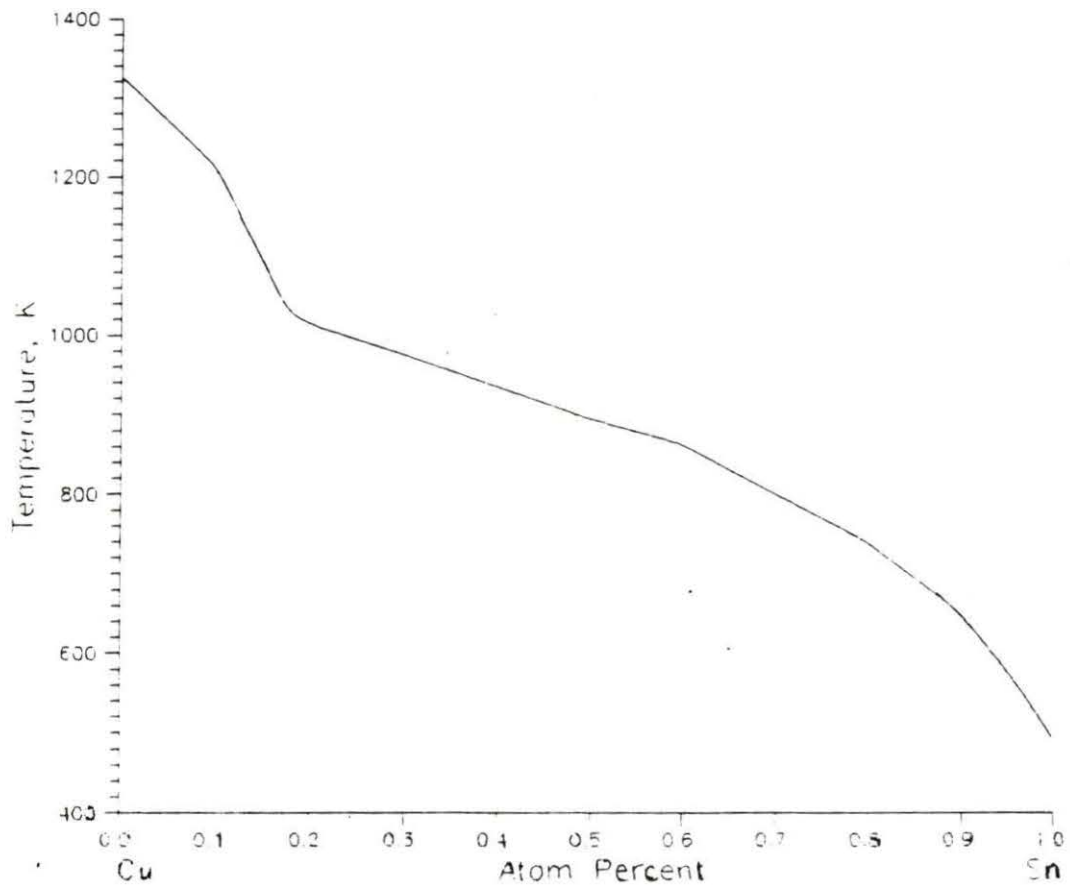

Figure 5.5: Copper-Tin Melting Point

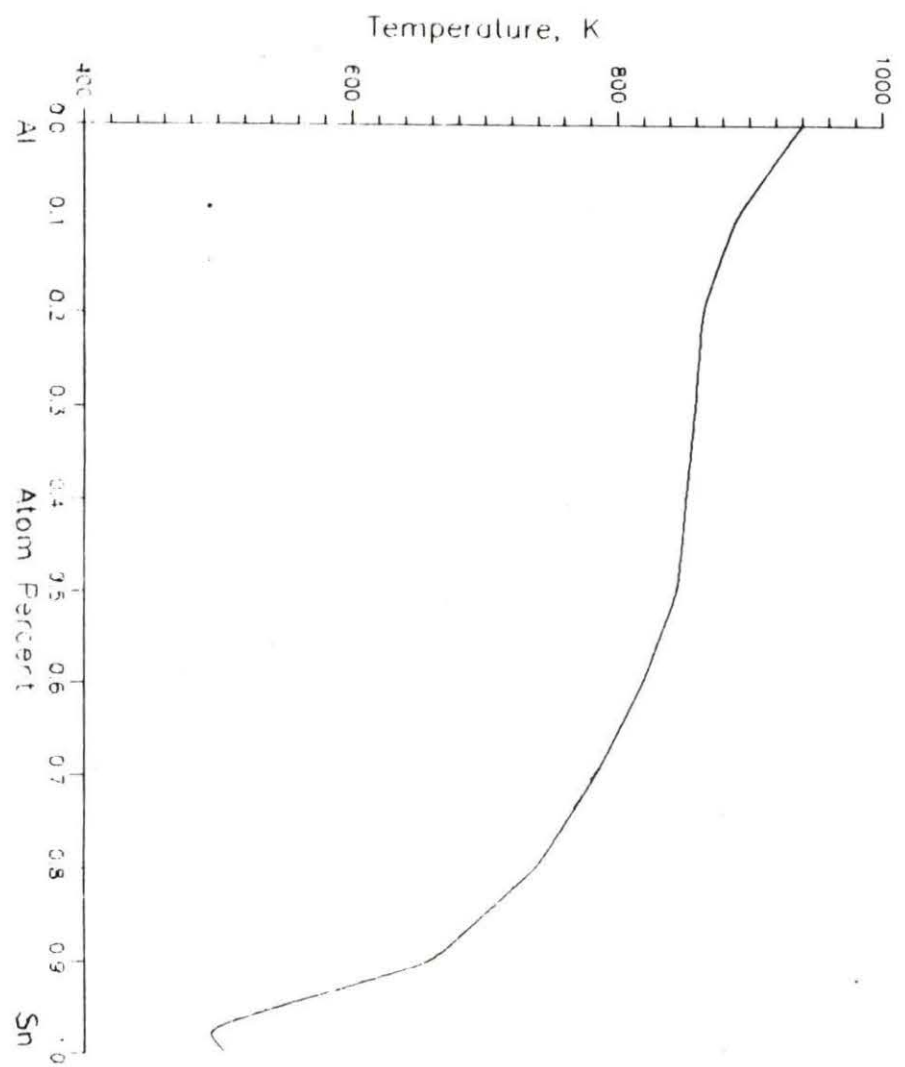

Figure 5.6: Aluminum-Tin Melting Point

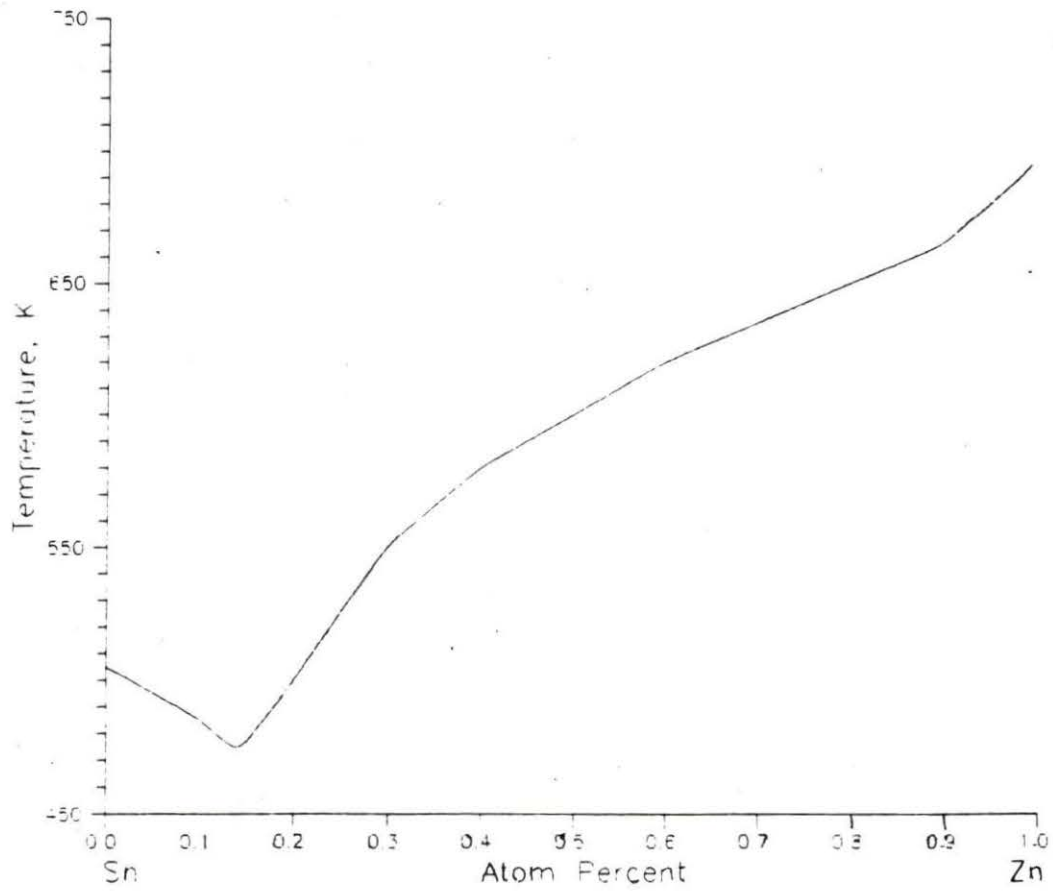

Figure 5.7: Tin-Zinc Melting Point

CHAPTER 6. COST ANALYSIS

In order to be considered a better design, the metal-filled canister concept must not only have better thermal and mechanical characteristics, but also prove to be cheaper than current canister designs. While there are many factors which go into determining the overall cost of repository storage, including the discount rate, and transportation and operation costs, these factors can be assumed to be essentially independent of the type of storage canister used and thus can be neglected.

Elimination of Bentonite

The factors considered in determining the cost savings were the elimination of the bentonite buffer and possibly the titanium and carbon steel overpack, less the cost of the metal filling material. These costs can be expressed in terms of a "per canister" unit cost which can then be related to an overall cost savings utilizing the new canister. These costs are evaluated on the basis of a metal-filled canister containing 6, 12, or 24 assemblies. Since one of the advantages the metal-filled canister might provide could be elimination of the bentonite buffer material, this is the first savings evaluated. The cost for an average amount of bentonite per borehole is estimated at \$1805. This is a conservative estimate, as some references have suggested much higher costs due to inspection and quality assurance of the buffer material [13].

Reduction in Borehole Drilling

Another reduction in costs would occur based on the number of boreholes that will need to be drilled. The drilling costs per unit depth for boreholes in tuff is given by the expression

$$1987 \text{ \$/m depth} = 900D \quad (6.1)$$

D = Diameter of borehole, m.

Current borehole design calls for drilling a borehole of diameter 88 cm for a borehole with air gap and 74 cm for a borehole with no air gap. Both of these dimensions are for boreholes containing canisters with 6 assemblies, with an inner diameter of 44 cm. When the buffer material is eliminated, the borehole diameter reduces to 64 cm for the borehole with air gap, and 50 cm for borehole with no air gap. A distance of 6 cm is added to the borehole to allow easier emplacement of the canister within the borehole. These figures become 70 cm for the air gap case, and 56 cm for the borehole with no air gap. Since the thermodynamic behavior of the metal-filled canister is such that no thermal limits will be violated, no air gap will be needed to provide better heat transfer [13, 20].

Taking this into consideration, the estimated cost of borehole drilling for the air gap case is equal to \$630/m, which for a depth of 4.2 m is equal to \$2650 per borehole. The cost of drilling for the case of no air gap is equal to \$504/m or \$2120 per borehole. For the case of no air gap and a canister containing 12 assemblies, the inner diameter is equal to 62 cm and the borehole diameter is equal to 74 cm and the equivalent drilling cost per borehole is \$2800. For a case of a canister containing

Table 6.1: Borehole Drilling Costs

<u># assemblies per canister</u>	<u># canisters per repository</u>	<u>Borehole drilling costs (\$10⁶)</u>	<u>Savings (\$10⁶)</u>
6	25532	54.1	13.5
12	12766	35.7	32.0
24	6383	24.1	43.6

24 assemblies and having no air gap, the borehole diameter is 1 m and the drilling cost per borehole is about \$3780.

Decrease in Number of Canisters

The cost savings for canisters containing 6,12, and 24, and with no air gap assemblies were figured in comparison to the cost for a canister containing 6 assemblies with an air gap. For a repository of size 72,000 MTHM, the number of assemblies to be stored is 153,192, which works out to be 25532 six-element canisters. The drilling cost for the repository for the air gap case comes to a total of \$67.7 million. In addition, the cost of the bentonite required to fill this many boreholes is equal to \$46.1 million. The costs of borehole drilling and subsequent savings for each case is shown in Table 6.1.

Add to this the savings due to elimination of the bentonite material and the overall savings would be as much as \$90 million for the case of a canister with 24 assemblies.

Other Possible Savings

There are still other areas in which savings may occur. One cost which will definitely be reduced, but which is difficult to determine precisely, is the mining costs. These are the costs needed to mine halls between rooms in the repository. Since less space will be needed if canisters containing 24 assemblies are used, the number of halls needed and therefore the cost of excavating these halls, will also be reduced.

In addition to the above savings, there remains the possibility of saving more by eliminating the titanium-carbon steel overpack. The purpose of the overpack is to maintain the structural integrity of the canister. This was designed for the case of air-filled canisters where the long thin fuel rods and canister might be susceptible to failure because of the lithostatic pressures in the repository. When a metal filling is added to the canister, the canister is better able to withstand lithostatic forces, possibly to the extent that little or no overpack might be needed. The cost of the titanium and carbon steel required for an overpack of inner diameter 45 cm and length 4.2 m is approximately \$19,000 per borehole [13]. When this is multiplied by 25532 boreholes for the 6-assembly case, the potential savings is about \$485 million. While it is uncertain whether this overpack can be totally eliminated, any reduction in the amount of overpack needed can create great savings over the current method of disposal storage.

Metal Filling Costs

In determining whether a metal-filled canister is a cheaper alternative than the current design, one more factor, the cost of filling the canister with metal, must be compared to the previously calculated savings. Since the ratio of metal-filling to fuel pin volume is constant regardless of the number of assemblies per canister, the total volume and therefore weight of the metal filling needed can be evaluated.

For a 6-assembly canister, the fuel pins occupy 73.8% of the canister. Since this canister has a radius of 22 cm and height of 4.1 m, the volume occupied by the metal filling is approximately $163,100 \text{ cm}^3$. For a tin metal filling, with a density of 7.3 g/cm^3 , this is equal to a weight of 1190 kg of tin per canister. Multiplying this by the 25,532 canisters needed to fill a repository yields a total weight of tin in the repository of 30,400 MT. While the price of tin has varied over the past 40 years from \$1 to \$4 per pound, the current price remains nearer the upper value of \$4 per pound[27, 29]. This value gives an estimate to the cost of the metal filling of about \$268 million. However, if a tin-zinc binary alloy were used as the metal filling, the cost would decrease because of the lower price of zinc. From the binary alloy diagrams, it can be seen that an alloy of about 50% zinc with 50% tin would be suitable for use in the canister. Since zinc is only about \$0.82/lb, as compared to tin at about \$3.77/lb, the cost of this binary alloy would be approximately \$2.3/lb. This type of metal filling would lead to a total cost of \$154 million. Because of this substantial savings, the use of a tin-zinc alloy must be considered the best choice for the metal filling.

Using the assumption that the overpack can be eliminated entirely and that a 6-assembly canister will be used, the savings incurred by the metal-filled canister are

about \$500 million. When the added costs of the metal filling are added in there is still an overall savings of around \$345 million. Although operation costs of the metal filling procedure have not been included, the operation is a simple enough procedure that it should be able to be done for much less than the \$345 million figure. Even under the assumption that only half of the overpack could be effectively eliminated, the savings are about \$256 million. This would still mean a \$100 million overall savings using the metal design. Regardless of what assumptions are made, the biggest potential savings using the metal-filled canister come from the elimination of the overpack material which can be accomplished to at least some degree by using the sturdier metal-filled canister.

CHAPTER 7. CONCLUSION

The purpose of looking at the alternative metal-filled fuel canister was to determine whether or not such a design could provide an improvement over the current canister design. It was initially assumed that such a canister would behave better thermodynamically and as a barrier to groundwater intrusion, but might be costly and add too much weight to the current canister design. During the analysis on the new canister design, these problems were explored.

Thermal Results

As expected, the new canister design performed better than the older design. The lowest estimate for effective conductivity for the metal-filled canister was approximately 7.0 W/m K, compared to an effective conductivity of approximately 0.85 W/m K for the gas-filled canister. For 10-year old spent fuel, this means a reduction in the canister temperature drop from about 80°C in the old canister to a value of about 10°C for the metal-filled canister. While neither of these canisters will have centerline temperatures near the 375°C stress rupture limit, the lower value in the metal-filled case allows more flexibility in the number of assemblies allowed per canister. Since the smaller space required to store canister underground decreases the cost of the storage, this is an important improvement, although other considera-

tions will have to be made in terms of the allowable weight of the package as well as the near and far-field temperatures created in the host rock. The near and far-field temperature limits are set in terms of an areal loading factor given in W/m^2 for the boreholes. These limits are set by limiting the stresses present between rooms and pillars due to the total heat generation in the repository as well as any changes that could occur in the geochemical or geophysical characteristics of the repository [13].

Protection Against Groundwater Entry

In addition to the decrease in temperature drop across the canister, the metal filling will also provide a major advantage in prevention of groundwater intrusion. While it has been projected that the current canister will be able to withstand groundwater intrusion for thousands of years, the addition of another solid barrier will provide even greater protection to the fuel rod's integrity. By adding the metal filling to surround the individual fuel rods, the groundwater will not even be able to begin attacking the fuel rod surface until the metal filling has been completely breached. Though the exact amount of time required to do this is unknown, the magnitude of added protection should be on the order of at least several hundred years.

Choice of Metal Filling

The choice of the metal used to fill the canister is an important one. The optimum choice was to have good thermal characteristics, an adequate melting point, and relatively inexpensive. Of the many metals and binary alloys looked at, the metals with the best physical properties were tin, tin babbitt, and a tin-zinc alloy. From these choices, the best metal is the 50% tin - 50% zinc alloy because of the

lower cost of the zinc as compared to the tin. This metal was selected because it has suitable thermal properties and is still inexpensive to add to the canister.

Disadvantages

The major disadvantages were assumed to be the increased weight and cost of the waste package. The addition of a tin or tin-zinc filling adds a weight of about 11 tons to the package. Considering the weight of the canister to be at least 50 tons and the weight of waste to be approximately 8 tons more, the percentage weight increase due to the addition of the tin is less than 20%. While this is significant and could become more substantial should larger waste packages be used; however, it is a small enough increase that the package should be manageable.

The cost of the metal-filled canister is difficult to pinpoint. There are enough parameters, such as the number of assemblies per canister, the amount of reduction in overpack, as well as changes in the cost estimates, that prevent an exact estimation of the cost or savings using the new design. What the cost analysis did show is that it appears likely that an overall savings can be achieved with the metal-filled canister. This is largely due to the savings that would be incurred by elimination of the Ti-steel overpack used for current canister designs. By eliminating most or all of this overpack, the metal-filled canister should be able to be produced cheaper than the current design.

Conclusions and Recommendations for Future Work

When all factors are taken into consideration, the benefit of using a metal-filled canister appears to be a plausible one. The canister provides improved thermody-

namic performance which allows for elimination of the air gap proposed in current canister design. In addition to this, the use of a metal filling adds a barrier against groundwater leaching that may eliminate the need for a bentonite backfill. Also, the metal-filled canister, being essentially a solid, is sturdier than its current counterpart, and this may eliminate the need for some or all of the Ti-steel overpack. All of these improvements lead to an overall savings using the metal-filled canister as well as a better performing waste package.

Since it is unknown exactly how much of the overpack can be eliminated and this is the biggest source of savings for the system, the first point at which further research should focus is in this area. It would be helpful to determine what kind of stresses are encountered by the metal-filled canister and how much overpack material, if any, would need to be added to keep structure mechanically sound. Also, the near and far-field areal loadings could be looked at to determine how closely the canisters and their respective boreholes can be placed together. Increasing the number of assemblies per canister decreases the number of canisters and boreholes, and therefore the cost, but increase the amount of space needed between boreholes due to the areal loading limits, which increases the cost. By balancing these two effects, an optimum number of assemblies per canister can be chosen for the metal-filled canister.

BIBLIOGRAPHY

- [1] C.M. Heeb, R.A. Libby, R.C. Walling, and W.L. Purcell. *Reactor-specific Spent Fuel Discharge Projections: 1985 to 2000*. PNL-5833. Richland,WA: Pacific Northwest Lab., 1986.
- [2] M. Benedict, T.H. Pigford, and H.W. Levi. *Nuclear Chemical Engineering*. New York,NY: McGraw-Hill Book Co., 1981.
- [3] J.R. Lamarsh. *Introduction to Nuclear Engineering*. Reading,MA: Addison Wesley Publishing Co., 1983.
- [4] A report by an Expert Group. *Nuclear Spent Fuel Management, Experience and Options*. Paris: Nuclear Energy Agency, Organisation for Economic Co-operation and Development, 1986.
- [5] H.W. Graves. *Nuclear Fuel Management*. New York,NY: John Wiley & Sons, 1979.
- [6] J.L. Zhu, and C.Y. Chun. *Radioactive Waste Management: World Overview, An Update of Trends and Developments*. Vienna: IAEA Bulletin 31, No. 4 (1989), 4-13.
- [7] Report of INFCE Working Group 6. *International Nuclear Fuel Cycle Evaluation: Spent Fuel Management*. Vienna: International Atomic Energy Agency, 1980.
- [8] S. Glasstone, and A. Sesonske. *Nuclear Reactor Engineering*. New York,NY: Van Nostrand Reinhold Co., 1981.
- [9] D.J. Bradley. *Spent Fuel Performance in Geologic Repository Environments*. PNL-SA-14767. Richland,WA: Pacific NW Labs, 1987.

- [10] S.P. Schneider, U.S. Department of Energy. *Spent Fuel Storage Situation At U.S. Reactors*. Presented to American Nuclear Society Fuel Cycle and Waste Management Division, Savannah, GA, 1982.
- [11] A.B. Johnson, Jr, P.A. Pankaskie, and E.R. Gilbert. *Spent Fuel Behaviour in Dry Storage*. in *Dry Storage of Spent Fuel Elements: Proceedings of NEA Specialist Workshop*. Madrid: Organisation for Economic Co-operation and Development, 1982.
- [12] *Spent Fuel Policy and its Implications*. American Nuclear Society, 1978.
- [13] J. Roglans-Ribas. *Disposal of Spent Nuclear Fuel and High-Level Waste: Design and Technical/Economic Analysis*. Ames,IA: Iowa State University Press, 1987.
- [14] R.S. Craig, J.R. Tomonto, and J.N. Vance. *Off-site Spent Fuel Storage Alternatives*. Presented to American Nuclear Society Fuel Cycle and Waste Management Division, Savannah, GA, 1982.
- [15] R.J. Steffen, and J.B. Wright. *Drywell Storage Potential*. Presented to American Nuclear Society Fuel Cycle and Waste Management Division, Savannah, GA, 1982.
- [16] M. Mason, K. Goldmann, P. Blum, and R. Christ. *Modular Container Designs for Dry Storage of Spent Fuel*. Presented to American Nuclear Society Fuel Cycle and Waste Management Division, Savannah, GA, 1982.
- [17] P.E. Eggers. *Storage and Transportation of Spent Fuel and High Level Waste Using Dry Storage Casks*. Presented to American Nuclear Society Fuel Cycle and Waste Management Division, Savannah, GA, 1982.
- [18] E.R. Johnson, and J.A. McBride. *Technical and Economic Assessment of Alternative Dry Storage Methods*. in *Dry Storage of Spent Fuel Elements: Proceedings of NEA Specialist Workshop*. Madrid: Organisation for Economic Co-operation and Development, 1982
- [19] *Regional Nuclear Fuel Cycle Centres, Basic Studies: 1977 Report of the IAEA Study Project*. Vienna: International Atomic Energy Agency, 1977.
- [20] Westinghouse Electric Corp. *Conceptual Waste Package Design for Disposal of Nuclear Waste in Tuff*. Columbus,OH: Batelle Memorial Institute, 1981.
- [21] M.M. El-Wakil. *Nuclear Heat Transport*. LaGrange Park,IL: The American Nuclear Society, 1978.

- [22] J. Lienhard. *A Heat Transfer Textbook*. Englewood Cliffs,NJ: Prentice-Hall, 1987.
- [23] J.P. Holman. *Heat Transfer*. New York,NY: McGraw-Hill, 1976.
- [24] J.J. Duderstadt, and L.J. Hamilton. *Nuclear Reactor Analysis*. New York,NY: John Wiley & Sons, 1976.
- [25] G. Linsley. *Protection of natural ecosystems: Impact of Radiation from Waste Diposal Practices*. Vienna: IAEA Bulletin, 31, No. 4 (1989), 29-31.
- [26] D.P.H. Hasselman, edited by D.P.H. Hasselman, J.R. Thomas, Jr. "*Thermal Diffusivity and Conductivity of Composites with Interfacial Thermal Contact Resistance*". *Thermal Conductivity 20*. New York,NY: Plenum Press, 1989.
- [27] C.T. Lynch, editor. *CRC Handbook of Materials Science. Vol. 1: General Properties*. Cleveland,OH: CRC Press, 1974.
- [28] F.W. Walker, D.G. Miller, and Dr. F. Feiner. *Chart of the Nuclides. Thirteenth Edition*. San Jose,CA: General Electric Co., 1984.
- [29] *The Wall Street Journal*. September 10,1990, Vol. 71, No. 229, pp. C12-13.
- [30] R.M.E. Diamant. *The Prevention of Corrosion*. London: Business Books Limited, 1971.
- [31] G. Butler, and H.C.K. Ison. *Corrosion and its Prevention in Waters*. New York,NY: Reinhold Publ. Corp., 1966.